

⚠ WARNING:

- Adult supervision required.
- Do not touch the spinning propellers. Keep fingers, hands, hair and loose clothing like shoestrings away from moving parts to avoid injury.
- Never hold or throw any objects into the spinning propellers.
- Risk of eye injuries. Keep a safe distance of at least 3 feet between you and the drone when flying.
- Do not fly the drones around people or pets.
- Use indoors only. Do not fly the drones in the vicinity of water or near power lines or ceiling fans.
- Do not submerge the drones or controllers in water.
- Never make modifications to the product.
- The operators are responsible for safe product use. Injuries or damage from improper usage are the sole responsibility of the user.
- Press the AUTO TAKE OFF / LANDING button and discontinue drone use immediately if the drones exit the line of sight.
- Never leave the drones unattended while the controllers are ON (I) and the drones are paired.

IMPORTANT INFORMATION

- Before each use, examine the drones, propellers, controllers and other parts for damage. Never operate this product if it has damaged parts. Replace broken or missing propellers before use.
- Flying drones takes skill and should be learned under direct supervision of an experienced adult.
- Always launch the drones from a flat, level surface and do not hold the drone during take off.
- For best results, use the drones in a large, open room without obstacles such as lamps, loose objects, etc.
- Always keep your eyes on the drones during use.
- Do not land or crash the drones near your head, your body or other people or pets.
- Stand up while flying the drones to get out of the way quickly if necessary.
- Always switch the controllers and drones to the OFF (O) position after use.
- Before recharging, allow the LiPo battery in the drones to cool for at least 10 minutes after use.
- Keep the product out of direct sunlight and avoid using in direct heat.
- Wipe the product with a damp cloth to clean. Air dry thoroughly in a well-ventilated area before storing.
- Illustrations are for reference only. Styles may vary from actual contents.



SKU: 518785

⚠ WARNING:
CHOKING HAZARD—Small parts.
Not for children under 3 years.

Ages 8+ years
ADULT SUPERVISION REQUIRED
BATTERIES INCLUDED

CONTENTS

- | | | | |
|--|------------------------|--------------------------|----------------------|
| A. 1 Red Drone | F. 1 Left Attack Saw | K. 1 Left Battle Hook | ALSO INCLUDES |
| B. 1 Red Controller | G. 1 Right Attack Saw | L. 1 Right Battle Hook | 1 Replacement Kit: |
| C. 1 Silver Drone | H. 1 Left Combat Star | M. 1 Left Assault Spear | - 4 A Propellers |
| D. 1 Silver Controller | I. 1 Right Combat Star | N. 1 Right Assault Spear | - 4 B Propellers |
| E. 2 Micro-USB Cables/
Charging Cords | J. 1 Curved Spear | O. 1 Double Hook | |

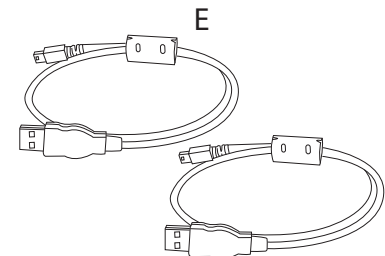
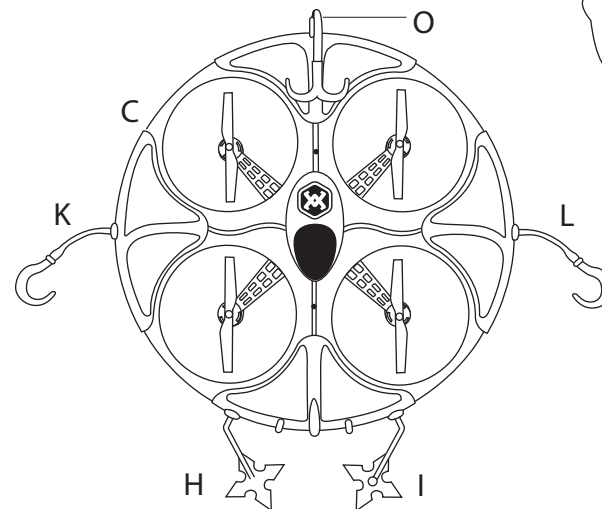
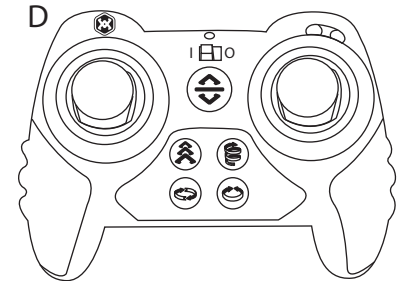
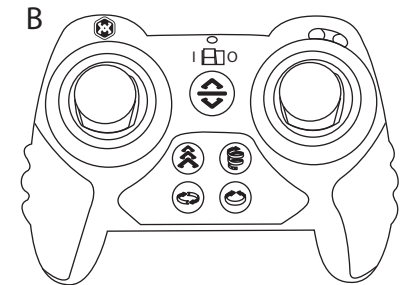
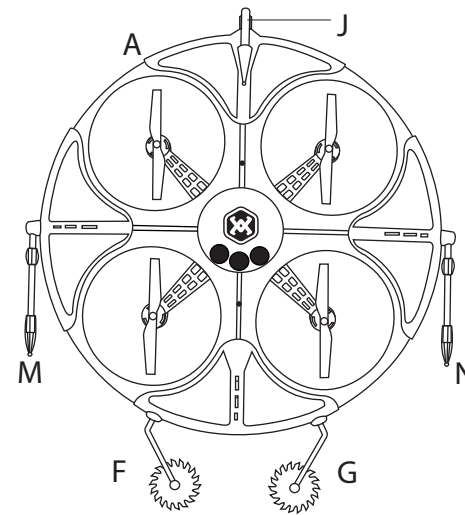

Replacement Kit:

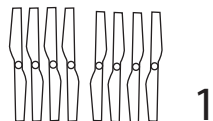

1



For more information, visit the Air Wars Battle Drones™ YouTube page for tutorials and stunt videos.



Please keep this manual as it contains important information.



0616-1-E/INT

© 2016 MGA Entertainment, Inc. AIR WARS™ and AIR WARS BATTLE DRONES™ are trademarks of MGA in the U.S. and other countries. All logos, names, characters, likenesses, images, slogans, and packaging appearance are the property of MGA. 16300 Roscoe Blvd. Van Nuys, CA 91406 U.S.A. (800) 222-4685
Printed in China

MGA Entertainment UK Ltd. 50 Presley Way Crownhill Milton Keynes, MK8 0ES Bucks, UK + 0800 521 558

Visit www.mgae.com to register your product and to enter our sweepstakes (No purchase necessary)

The preferred method of contact for Customer Service is through our e-mail contact form at www.mgae.com

GAME PLAY

Air Wars Battle Drones™ are new quad copters that can physically strike other drones!
Load your weapons, launch your drone and knock your rival out of the sky™.

OBJECTIVE:

Battle your friends! Attach weapons to your drone and take down your opponent's drone. Use programmed attacks to battle the opposing drone or use the controller joysticks to create your own attacks.

DETERMINING A WINNER:

Standard Battle:

Both drones may crash in the battle, but the winner of each round is the drone that makes the final attack. Replace any fallen weapons before battling again. After 10 rounds, tally up total wins to determine the ultimate battle champion.

Weapon Defender:

Alternate the weapon configuration on each drone and trade weapons with your opponent to create epic battles. After each battle, do not replace any fallen weapons. The drone that can successfully remove all weapons from its opponent wins.

SINGLE PLAYER MODE:

Pair one controller to one drone and practice maneuvers on your own. Set up targets throughout the room to practice stunts, landing and attacking. Find more tips and tricks by subscribing to the Air Wars Battle Drones™ YouTube channel.

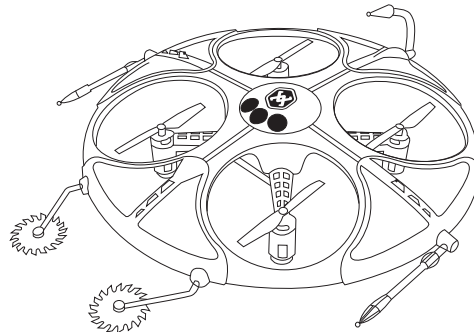
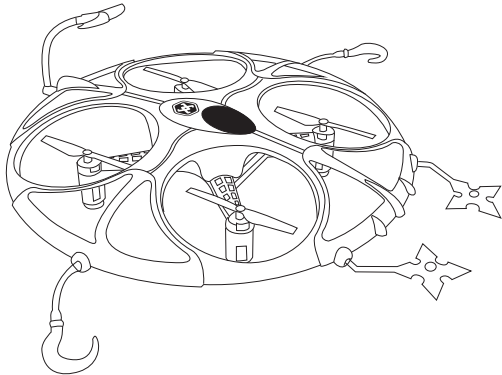

REPLACING CONTROLLER BATTERIES

An adult must install fresh alkaline batteries in the controllers should the included batteries need replacing. Here's how:

1. Using a Phillips screwdriver (not included) remove the screws and battery compartment covers from the backs of the controllers.
2. Install three (3) fresh 1.5V AAA (LR03) alkaline batteries (not included) in each controller making sure the (+) and (-) ends face the proper direction as indicated inside the battery compartment.
3. Replace the compartment covers and tighten the screws.

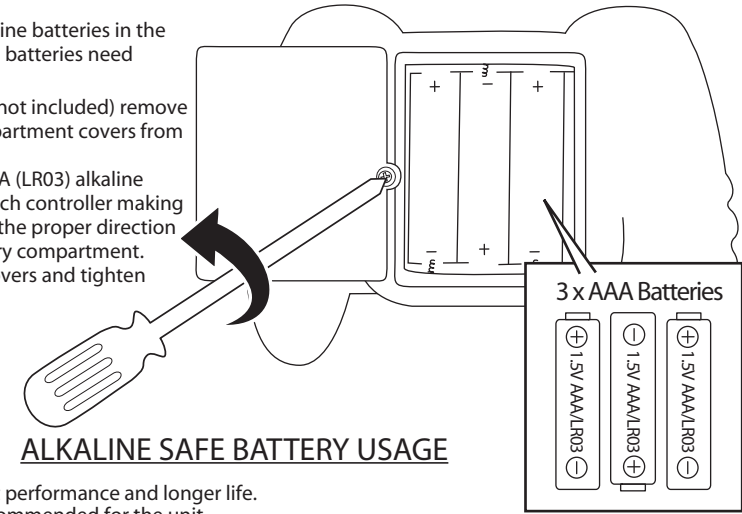

ALKALINE SAFE BATTERY USAGE

- Use alkaline batteries for best performance and longer life.
- Use only the type battery recommended for the unit.
- Batteries should be replaced only by an adult.
- Insert batteries with the correct polarity (+ and -).
- Do not mix old and new batteries.
- Do not mix alkaline, standard (carbon-zinc), or rechargeable (nickel-cadmium) batteries.
- Do not short-circuit batteries.
- When not used for an extended time, remove batteries to prevent possible leakage and damage to the unit.
- Do not mix rechargeable and non-rechargeable batteries.
- Rechargeable batteries are to be removed from the toy before charging.
- Rechargeable batteries are to be recharged only under adult supervision.
- Do not recharge non-rechargeable batteries.
- Exhausted batteries are to be removed from the toy.
- Do not dispose of batteries in fire as they may leak or explode.

FCC COMPLIANCE

NOTE: This equipment has been tested and found to comply with the limits for a Class B digital device, pursuant to Part 15 of the FCC Rules. These limits are designed to provide reasonable protection against harmful interference in a residential installation. This equipment generates, uses and can radiate radio frequency energy and, if not installed and used in accordance with the instructions, may cause harmful interference to radio communications. However, there is no guarantee that interference will not occur in a particular installation. If this equipment does cause harmful interference to radio or television reception, which can be determined by turning the equipment off and on, the user is encouraged to try to correct the interference by one or more of the following measures:

- Reorient or relocate the receiving antenna.
- Increase the separation between the equipment and receiver.
- Connect the equipment into an outlet on a circuit different from that to which the receiver is connected.
- Consult the dealer or an experienced radio/TV technician for help.

This device complies with Part 15 of the FCC Rules. Operation is subject to the following two conditions: (1) This device may not cause harmful interference, and (2) this device must accept any interference received, including interference that may cause undesired operation.

Warning: Changes or modifications to this unit not expressly approved by the party responsible for compliance could void the user's authority to operate the equipment.



'Let's care for the environment!'

The wheeled bin symbol indicates that the product must not be disposed of with other household waste. Please use designated collection points or recycling facilities when disposing of the item. Do not treat old batteries as household waste. Take them to a designated recycling facility.

CHARGING THE DRONE BATTERIES

NOTE: Fully charged drones will operate for about 6 minutes.

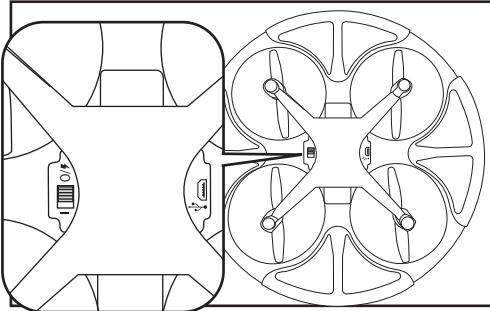

Turn the drone OFF/CHARGING (O/⏻).

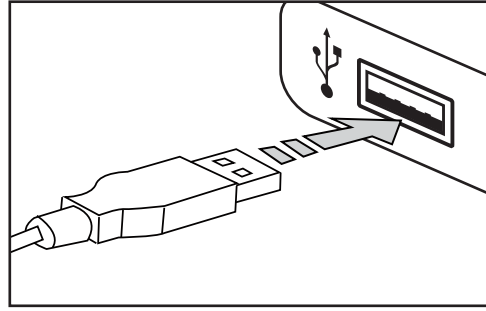

Plug charging cord into a computer (not included) that is turned on or wall adapter (not included).

NOTE: Wall adapters may result in faster charge time.

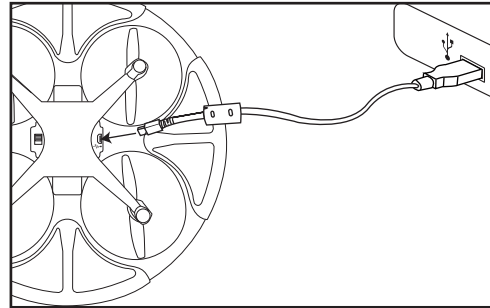

Plug the charging cord into the drone until the battery is fully charged.

- Blinking red LED on top of drone indicates charging.
- When the green LED on top of the drone lights up, charging is complete.

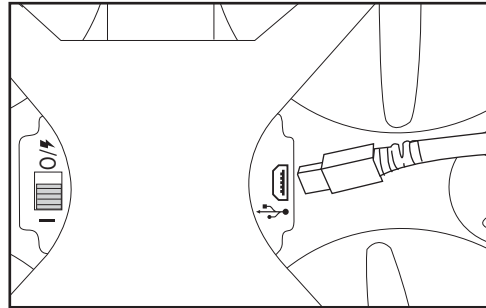

Unplug the charging cord from the drone and charging source. Then, turn the drone ON (I).

LiPo BATTERY SAFE USAGE

The drones are equipped with LiPo rechargeable batteries. Please pay attention to the following cautions for safety use:

- Before recharging, allow the LiPo batteries in the drones to cool for at least 10 minutes after use.
- Do not dispose of the battery in fire or extreme heat.
- Do not use or leave the battery near a heat source such as a fire or a heater.
- Do not strike or throw the battery against hard surfaces.
- Do not immerse the battery in water, and keep the battery in a cool, dry place.
- When recharging, only use the battery charger specifically included for that purpose.
- Do not over-charge the battery.
- Do not directly solder the battery and pierce the battery with a nail or other sharp object.
- Do not disassemble or alter the battery.
- Charge the battery every 6 months and as necessary.
- Do not transport or store the battery with metal objects such as necklaces, hairpins, etc.
- Please recycle a used battery after covering the battery terminals with insulation tape or inserting it into an individual poly bag. Check local laws and regulations for recycling and/or disposal information.
- Batteries inside the drones are not replaceable.
- Under the environment with electrostatic discharge, the product may malfunction and require the user to reset the product by turning it off and back on again.

BEFORE YOU BEGIN

1 CHARGE AND REPLACE BATTERIES

The batteries included in your controllers and the batteries on the drones come ready to play at 50% battery power. Before you begin, it is recommended that an adult change the batteries in the controllers and charge the drone batteries to ensure a full play cycle.

For battery charging and replacement information, please see pages 10 and 11.

2 INSPECTION

Inspect all propellers thoroughly before take-off. If any part of the drone is damaged, do not attempt to fly it until the damage has been fixed. Do not attempt to modify the product in any way. If damage is beyond repair, contact customer service.

3 ATTACH WEAPONS

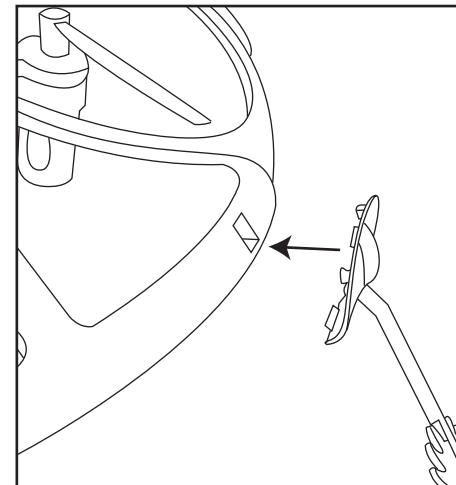
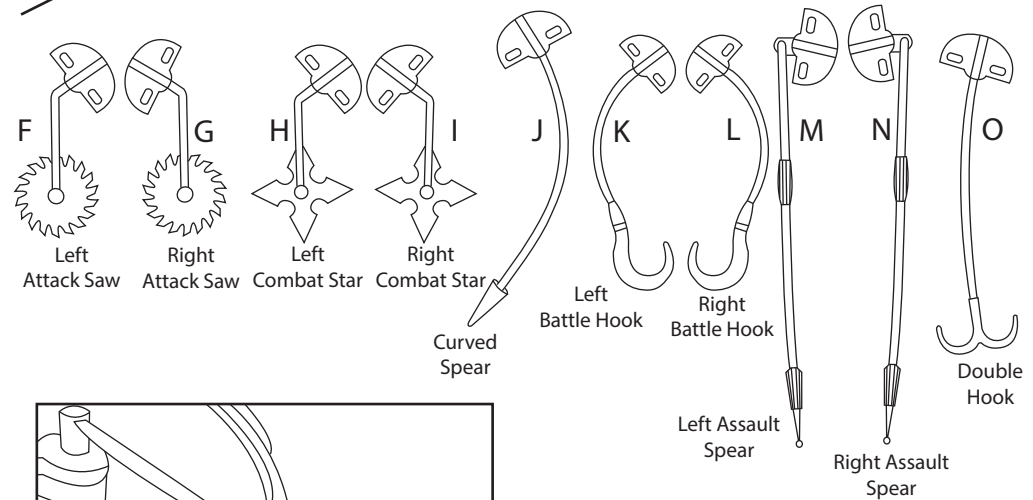

Attach the clips on the ends of the weapons to the outer rim of the drones. Then, press to clip them in place.

While weapons can be added anywhere on the rim, it is recommended that you clip them into the grooves.

For best performance, follow the weapon placement under CONTENTS on page 1.

PAIRING CONTROLLERS TO DRONES

IMPORTANT: Pair only one drone to one controller at a time to prevent interference between drones.

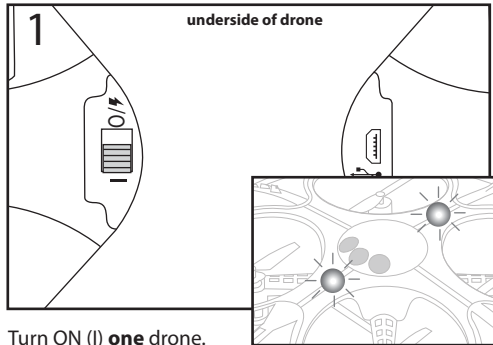

1 Turn ON (I) **one** drone. Both lights on top of the drone will blink.

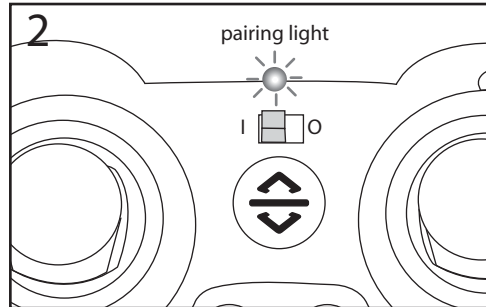

2 Turn ON (I) **one** controller. The pairing light will blink.

NOTE: Pairing works best with distance of approximately 3 feet between the controller and the drone.

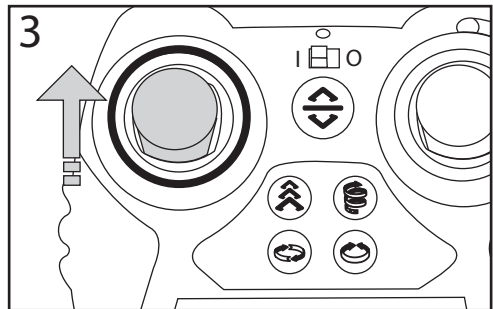

3 Move left joystick up. The controller will beep once.

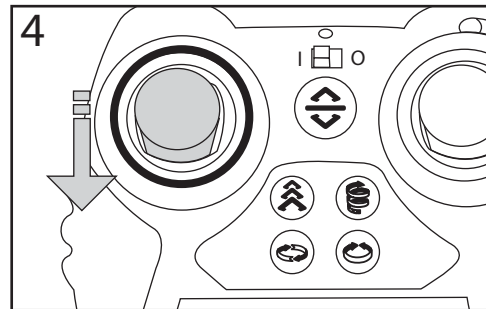

4 Move left joystick down. The controller will beep once.

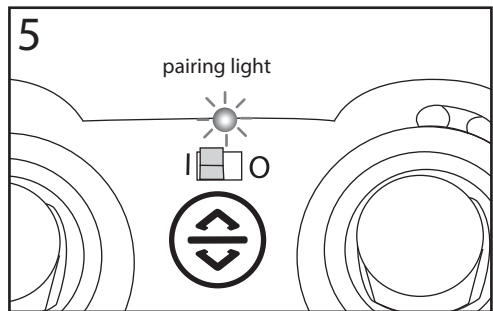

5 Wait until the pairing light stays on for both the controller and drone.

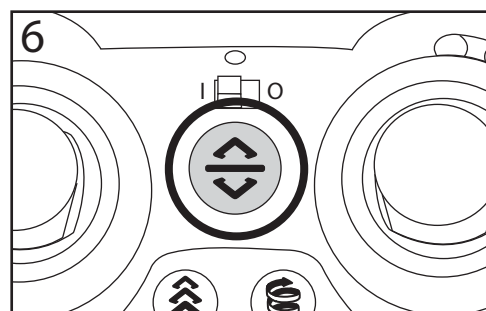

6 Press AUTO TAKE OFF / LANDING button to hover.

REPEAT FOR ADDITIONAL DRONE.

TROUBLESHOOTING

1 Drone is not flying or is flying erratically:

- The drone may have been unpaired from its controller. Pair the drone to the controller again.
 - Turn OFF (O/⚡) the drone and the controller for 30 seconds before pairing again.
- Point the controller towards the drone when flying and stay within 50 feet of the drone at all times.
- Check the drone thoroughly for any damage or missing parts.
- The drone may shutdown on its own if it detects a problem.
 - To restart, turn OFF (O/⚡) the drone and back ON (I).
- Then, pair the controller and try again.
- If the drone seems unstable after a crash, recalibrate it.
 - Turn ON (I) one controller and one drone.
 - Pair the drone to the controller. Drone and controller lights will be solid.
 - Push and hold both joysticks on the controller to the bottom left.
 - The red and green drone lights will blink for several seconds.
 - The lights will remain solid when calibration is complete.

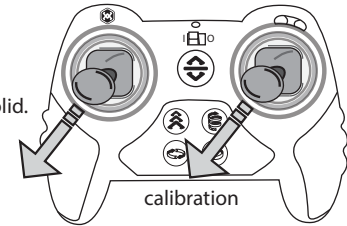

2 The propellers move, but the drone does not fly:

- The propellers may be broken. Check for broken or missing propellers and replace as necessary.
- The propellers may be installed incorrectly. Make sure the propellers are in the proper location on the drone and reinstall. Never push the propellers too far or too hard onto the drone to prevent binding.

3 The drone drifts when hovering:

- Try adjusting the trim if the drone is off balance.

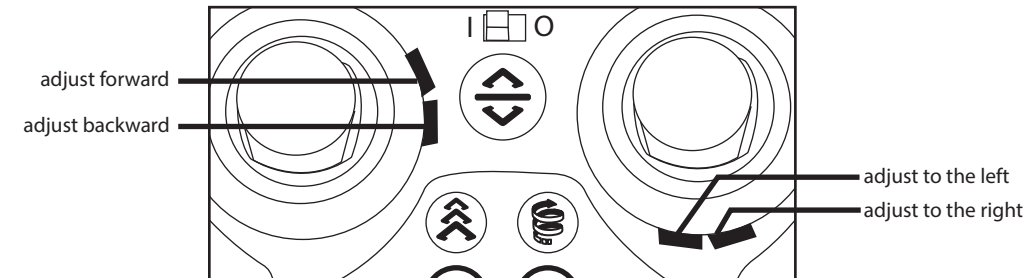

4 The drone will not fly after pairing:

- After you turn ON (I) the drone and place it on a flat surface, you only have a few seconds to pair. Turn on the controller. Then, quickly press the joystick up, then down. Once the pairing light turns off, press the AUTO TAKE OFF / LANDING button.
- Pairing works best with distance of approximately 3 feet between the controller and the drone.

5 The drone crashes unexpectedly:

- The drone may need to be recharged. Follow the charging directions and allow the drone to charge fully before operating. Each full charge will lend approximately 6 minutes of play time.
- Confirm the propellers are properly attached to the drone in their respective locations.

6 One drone always beats the other during battles:

- Attach different weapons or rearrange weapons on the drone.
- Weapons are intended to fall off during battle crashes. Reattach any fallen weapons before the next battle.
- Change the drone speed when you are comfortable maneuvering the drone.

REPLACING BROKEN OR MISSING PROPELLERS

- 1 Turn the drone OFF (O/⚡).
- 2
 - Note which propeller(s) need(s) to be replaced.
 - Note the letter (A, B) under the broken propeller(s).
 - If a propeller is missing, refer to the diagram on this page to see where each propeller belongs.

- 3 **Remove** the broken propeller if it is still attached.

- 4 Securely snap on the new propeller.

- 5 Loose hair or other debris may get caught in the propellers over time. To remove, turn the drone OFF (O/⚡), take off the propeller, remove the debris, and reinstall the propeller.

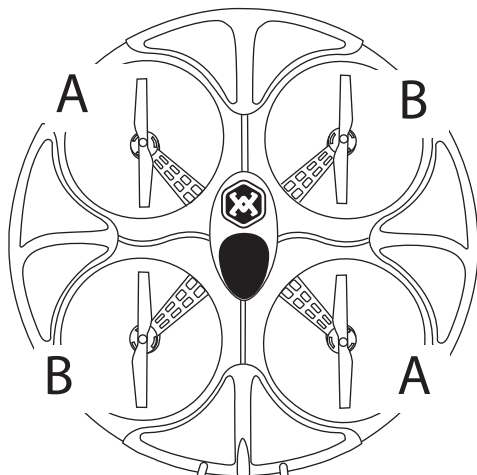
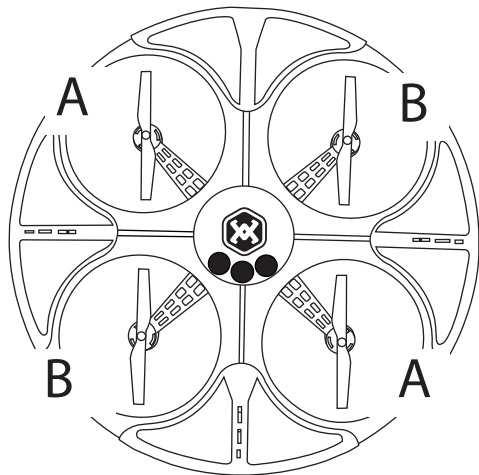
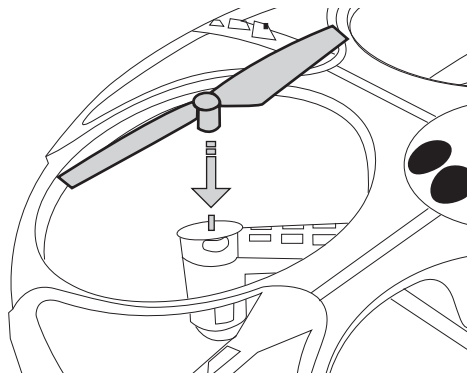

⚠ WARNING:

- Do not fly drones with broken propellers as it may cause damage or injury.
- Do not attempt to replace propellers with propellers of a different letter. The drone will not fly if propellers are not installed properly.
- If the propellers stop rotating or become jammed, immediately press and hold the landing / emergency stop button for two seconds. When the drone is fully landed and stopped, turn OFF (O/⚡) the drone and remove any interference.

FLYING PRACTICE + FLYING TIPS

Flying a drone takes practice and skill and should be learned under adult supervision.

Keep receiver pointed at the drone during flight.

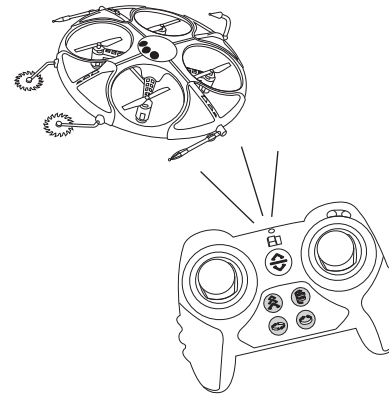

Practice hovering about 5 feet off the ground.

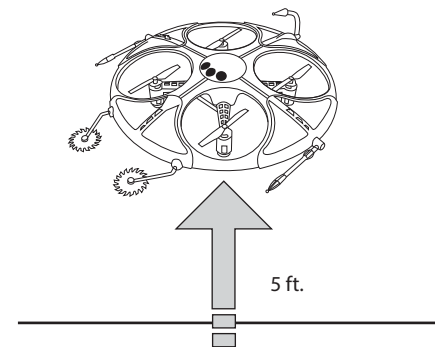

Keep the drone 3 feet away from walls and ceilings to prevent crashes and damage.

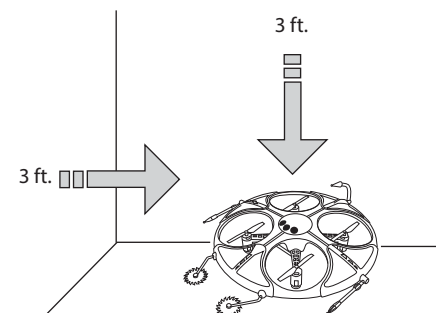

Set the speed to level 1 (learning mode) until you are comfortable going faster.

level 1: learning (slow)
level 2: medium
level 3: fast

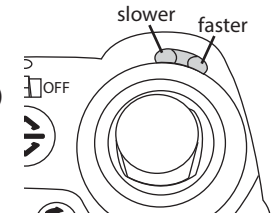

Practice tapping the joysticks in any direction. Do not hold the joysticks in any single direction until you have a feel for how quickly the drone will move.

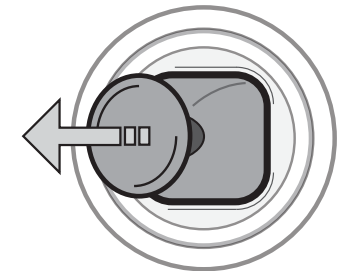

If you crash, immediately press and hold the landing / emergency stop button for two seconds.

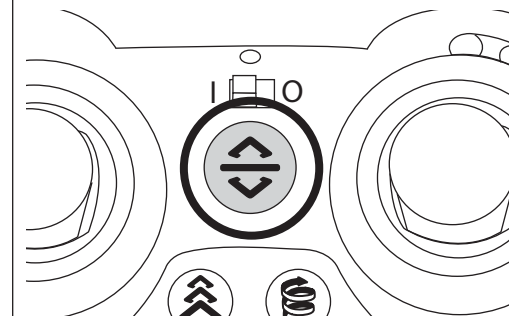

CONTROLLING DRONE FLIGHT

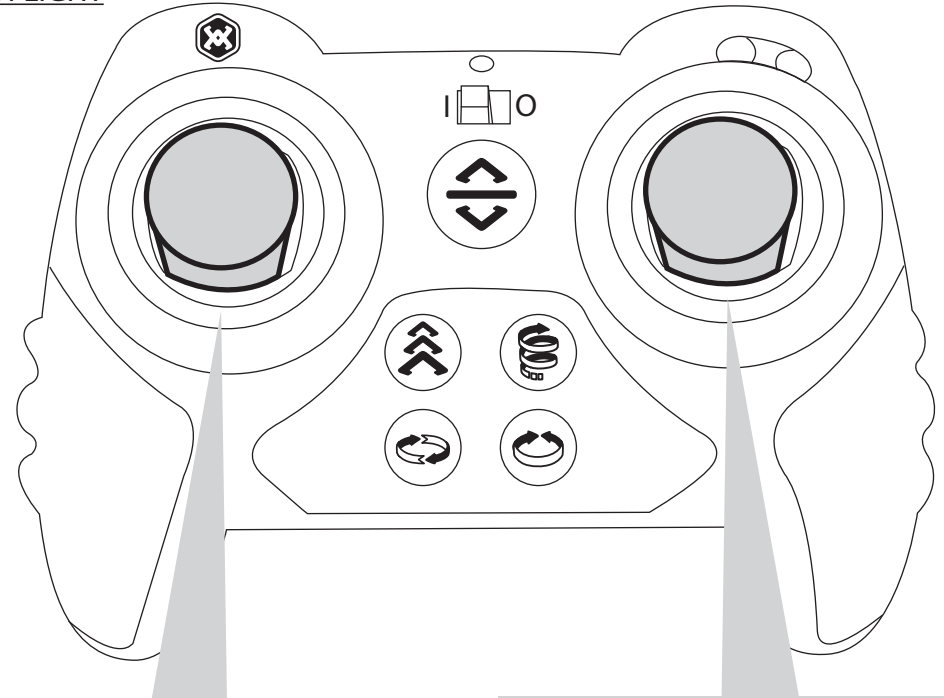
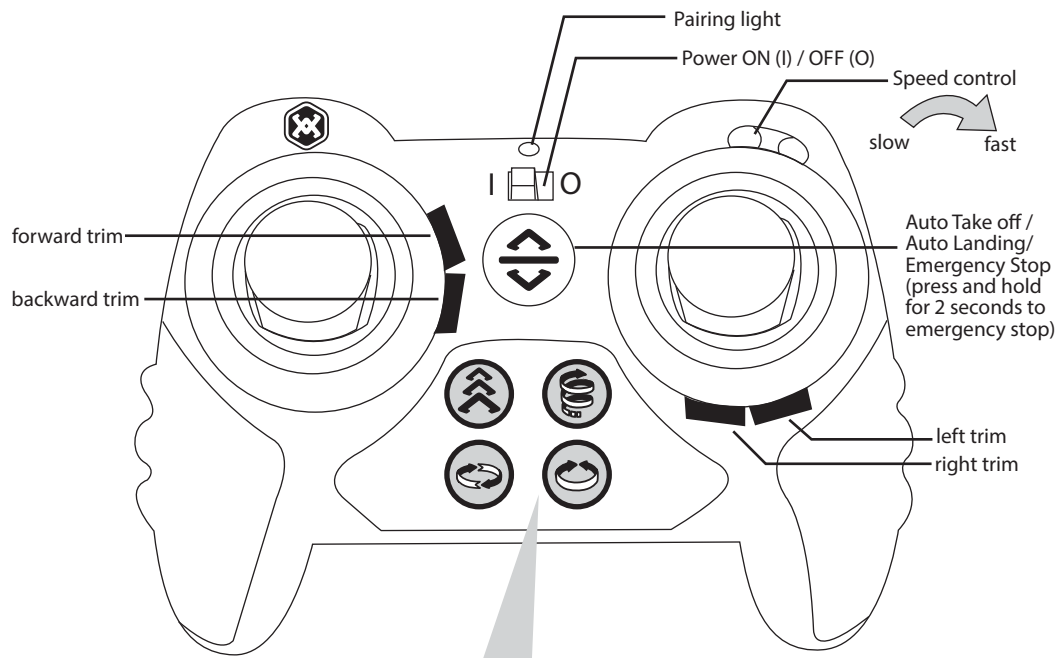

PROGRAMMED ATTACKS

